

**MARINE**

***SCANSTRUT***<sup>®</sup>

THE MARINE COLLECTION

## outdoor • technologies



Design



Innovation



Partner



Quality



Sustainability

## The Story (So Far)

Scanstrut is a global leader in marine and outdoor equipment, manufacturing cutting-edge outdoor technologies for over 40 years. We began with a passion for enabling adventure, and we've since grown into a company recognised worldwide for our quality, reliability, and innovation.

With a diverse product range of over 350 items, we enhance the use of navigation, and personal electronics in the outdoors. Our products are organized into four main categories: mounts, charge, air, and seal. Scanstrut remains proudly independent, with headquarters in the UK and the USA. Over the decades, our journey has been marked by numerous industry firsts, including the development of ground-breaking mounting systems and wireless charging technologies for outdoor environments. These milestones have earned us numerous awards.

Every innovation is born in-house, driven by our talented design and engineering team who carry ideas from concept through to production. We ensure that every product meets the highest standards, trusted by customers in the toughest environments.

Our journey is one of passion, precision, and pushing boundaries, and we're excited to keep driving forward, innovating, and enabling your adventures, wherever it may take you.



---

**SCA Introduction** 06-07

---

**Mount**

Radar Mounts	08-29
Satcom Mounts	30-33
Starlink Mounts	34-35
Thermal Camera Mounts	36-37
Scanpods	38-47
Phone & Tablet Mounts	48-49

---

**Charge**

USB Charging	50-57
Wireless Charging	58-67

---

**Air**

Integrated Air Station	68-73
------------------------	-------

---

**Seal**

Vertical Cable Seals	74-77
Horizontal Cable Seals	78-79
Low Profile Cable Seals	80-81
Multi Cable Seals	82-83
Through Bulkhead & Junction Boxes	84-85

---

**Get in Touch** 86



## Testing Process



**On Water Test**  
Dynamic on water testing in harsh coastal conditions. Mounted to a test vessel to evaluate its performance in rough sea states.



**Corrosion Test**  
100-hours of a special formula salt spray that simulates accelerated marine environmental effects on the product.



**IP Test**  
Water and dust protection under test laboratory conditions to international IP standards. We test between IPX4 (waterjet) and IP68 (submersion).



**Impact Test**  
Drop tests to assess the impact of items falling onto our products and ensure they can withstand impacts while being used as intended.



**Cable Bend Test**  
Electrical products are bolted into a specially designed automated jig to mechanically bend the cable -45° to +45° for 3000 cycles. This ensures cables will not fail even after prolonged use.



**On Water Charge Test**  
Using real life on water temperature data to ensure devices will continue to charge at an acceptable speed in extreme cold and hot temperatures.



**Accelerated UV Material Test**  
We accelerate the effects of UV exposure to replicate our products usage in extreme tropical climates. We do this to ensure parts do not become brittle, discolour or fail over time.



**Humidity Chamber Test**  
Similar to our brutal SCA Thermal Chamber Test, but we've added humidity to make it even more punishing.



**Shaker Table Test**  
Shock testing in X / Y / Z and +/- axis at 5G increments up to 30G to evaluate the products strength, particularly relevant for our Radar mounts.



**FEA Analysis**  
Finite Element Analysis, simulates the behaviour of the design in virtual conditions to allow us to optimise the design before prototyping and physical testing.



**30G Shock Test**  
Shock testing at 30G (30 times the force of gravity) to evaluate strength, particularly relevant for our Radar mounts and other powerboat products.



**Material Test**  
Positive Material Identification (PMI) ensures consistent quality of 316 Stainless Steel and Aluminium products. This controls strength and environmental performance.



**Cable Twist Test**  
Electrical products are bolted into a specially designed automated jig to mechanically twist the cable -45° to +45° for 3000 cycles. This ensures cables will not fail even after prolonged use.



**Thermal Chamber Test**  
Laboratory chamber running from -40°C (-40°F) to +85°C (185°F) and back to -40°C (-40°F) for 120 cycles, this accelerates material ageing to simulate real world environment.



**Temperature Chamber Test**  
Product placed in a laboratory chamber at high temperatures to ensure our products continue to perform as designed.



**On Water Testing Global**  
Similar to SCA standard on water testing, however we select locations and vessels for more varied and challenging environmental conditions.



## Safe • Certified • Approved

The testing standard at Scanstrut is encapsulated by the acronym SCA, which stands for Safe, Certified, and Approved. With over 35 years of experience and expertise in designing products for outdoor use, we design our products to be able to thrive in the harshest of outdoor environments.

Before any product is released, it must pass through our rigorous testing program which involves relevant assessments in electrical, mechanical, U.V., corrosion, thermal, and waterproof categories. To ensure the highest level of accuracy, testing is conducted both internally and by independent accredited test houses.

Our commitment to quality has earned us the approval of renowned names such as Mercury Marine, Grady White Boats, Boston Whaler, Winnebago, Airstream and many more. To learn more about our testing program and certifications, please feel free to reach out to us.









## Radar Mount

Discover the ultimate solutions for mounting your radar with our premium Radar Mounts. Engineered for stability and durability, our mounts ensure your radar operates at peak performance, even in challenging marine conditions. With easy installation and a sleek design, our mounts seamlessly integrate with your vessel while providing optimal visibility and functionality.

---



-  Pre-drilled mounting holes to allow radar to fasten straight to the PowerTower
-  No need to cut the radar's connectors off for installation
-  Marine sealant not required
-  2 x heights available
-  Aft or forward leaning designs
-  Marine-grade aluminium
-  Unique 4 step marine paint system

# Aluminium PowerTower®

Scanstrut Aluminium PowerTower has been designed and engineered to install your radar on the roof, T-top, flybridge or radar arch of your powerboat, providing the clearest view of the horizon allowing you to get the best performance from your radar in all conditions.

Available in



**APT-150-01**  
**Aluminium PowerTower®**  
 Colour White  
 Height 150mm / 6"  
 Leaning Aft

GPS, VHF & Navlight Compatible  
 Cable seal built into the top of the tower



**APT-250-01**  
**Aluminium PowerTower®**  
 Colour White  
 Height 250mm / 10"  
 Leaning Aft

GPS, VHF & Navlight Compatible  
 Cable seal built into the top of the tower



**APT-150-01-BLK**  
**Aluminium PowerTower®**  
 Colour Black  
 Height 150mm / 6"  
 Leaning Aft

GPS, VHF & Navlight Compatible  
 Cable seal built into the top of the tower



**APT-250-01-BLK**  
**Aluminium PowerTower®**  
 Colour Black  
 Height 250mm / 10"  
 Leaning Aft

GPS, VHF & Navlight Compatible  
 Cable seal built into the top of the tower



**APT-150-02**  
**Aluminium PowerTower®**  
 Colour White  
 Height 150mm / 6"  
 Leaning Aft

GPS, VHF & Navlight Compatible  
 Cable seal built into the top of the tower



**APT-250-02**  
**Aluminium PowerTower®**  
 Colour White  
 Height 250mm / 10"  
 Leaning Aft

GPS, VHF & Navlight Compatible  
 Cable seal built into the top of the tower

**Compatible with**

- ✓ Garmin
- ✓ Raymarine
- ✓ Simrad
- ✓ Lowrance

- ✓ Garmin
- ✓ Raymarine
- ✓ Simrad
- ✓ Lowrance

- ✓ Garmin
- ✓ Raymarine
- ✓ Simrad
- ✓ Lowrance

- ✓ Garmin
- ✓ Raymarine
- ✓ Simrad
- ✓ Lowrance

- ✓ Furuno

- ✓ Furuno

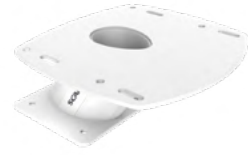

**APT-F-150-01**  
**Aluminium PowerTower®**  
 Colour White  
 Height 150mm / 6"  
 Leaning Forward  
 Navlight Compatible

- Compatible with
- ✓ Garmin
  - ✓ Raymarine
  - ✓ Simrad
  - ✓ Lowrance



**APT-F-250-01**  
**Aluminium PowerTower®**  
 Colour White  
 Height 250mm / 10"  
 Leaning Forward  
 Navlight Compatible

- Compatible with
- ✓ Garmin
  - ✓ Raymarine
  - ✓ Simrad
  - ✓ Lowrance



**APT-F-150-02**  
**Aluminium PowerTower®**  
 Colour White  
 Height 150mm / 6"  
 Leaning Forward  
 Navlight Compatible

- Compatible with
- ✓ Furuno



**APT-F-250-02**  
**Aluminium PowerTower®**  
 Colour White  
 Height 250mm / 10"  
 Leaning Forward  
 Navlight Compatible

- Compatible with
- ✓ Furuno



**APT-GPS-01**  
 Central GPS / VHF Antenna Bar  
 with 1" x 14 TPI thread

- Compatible with
- ✓ APT-150-01
  - ✓ APT-250-01
  - ✓ APT-150-02
  - ✓ APT-250-02



**APT-LB-01**  
 Mounts Hella, Perko, Aqua Signal  
 & Lopolights

- Compatible with
- ✓ APT-150-01
  - ✓ APT-250-01
  - ✓ APT-150-02
  - ✓ APT-250-02



**APT-LB-01-BLK**  
 Mounts Hella, Perko, Aqua Signal  
 & Lopolights

- Compatible with
- ✓ APT-150-01-BLK
  - ✓ APT-250-01-BLK



**APT-LB-GPS2-01**  
 Designed for 2x Antenna and  
 1x Navlight

- Compatible with
- ✓ APT-150-01
  - ✓ APT-250-01
  - ✓ APT-150-02
  - ✓ APT-250-02



**APT-LB-L1**  
 All Round White LED Light  
 COLREG 1972 Approved  
 USCG 2NM

- Compatible with
- ✓ APT-150-01
  - ✓ APT-250-01
  - ✓ APT-150-02
  - ✓ APT-250-02



**APT-F-LB-01**  
 Mounts Hella, Perko Aqua Signal  
 & Lopolights

- Compatible with
- ✓ APT-F-150-01
  - ✓ APT-F-250-01
  - ✓ APT-150-02
  - ✓ APT-250-02





Pre-drilled mounting holes to allow radar or antenna to fasten straight to the mount



No need to cut the radar's plugs or antenna off to install



Marine sealant not required



Marine-grade aluminium



Unique 4 step marine paint system



2 x heights available



# Modular Dual PowerTower®

This “off the shelf custom mount” allows the greatest flexibility for selecting a simple solution that works for your requirements. Mount 2 electronics on 1 footprint, with a choice of 3 main strut types and a range of electronics plates. The Modular Dual PowerTower has been designed to allow your open array or radar & satcom, Starlink or camera to be mounted together with or without navlights, creating that custom mount that is perfect for your boat.

Available in



◆ To build your own Modular Dual PowerTower simply choose your mount, radar plate, top plate & light bar.

See our simple 4 step buyers guide Page 16-17 or visit [scanstrut.com](http://scanstrut.com)

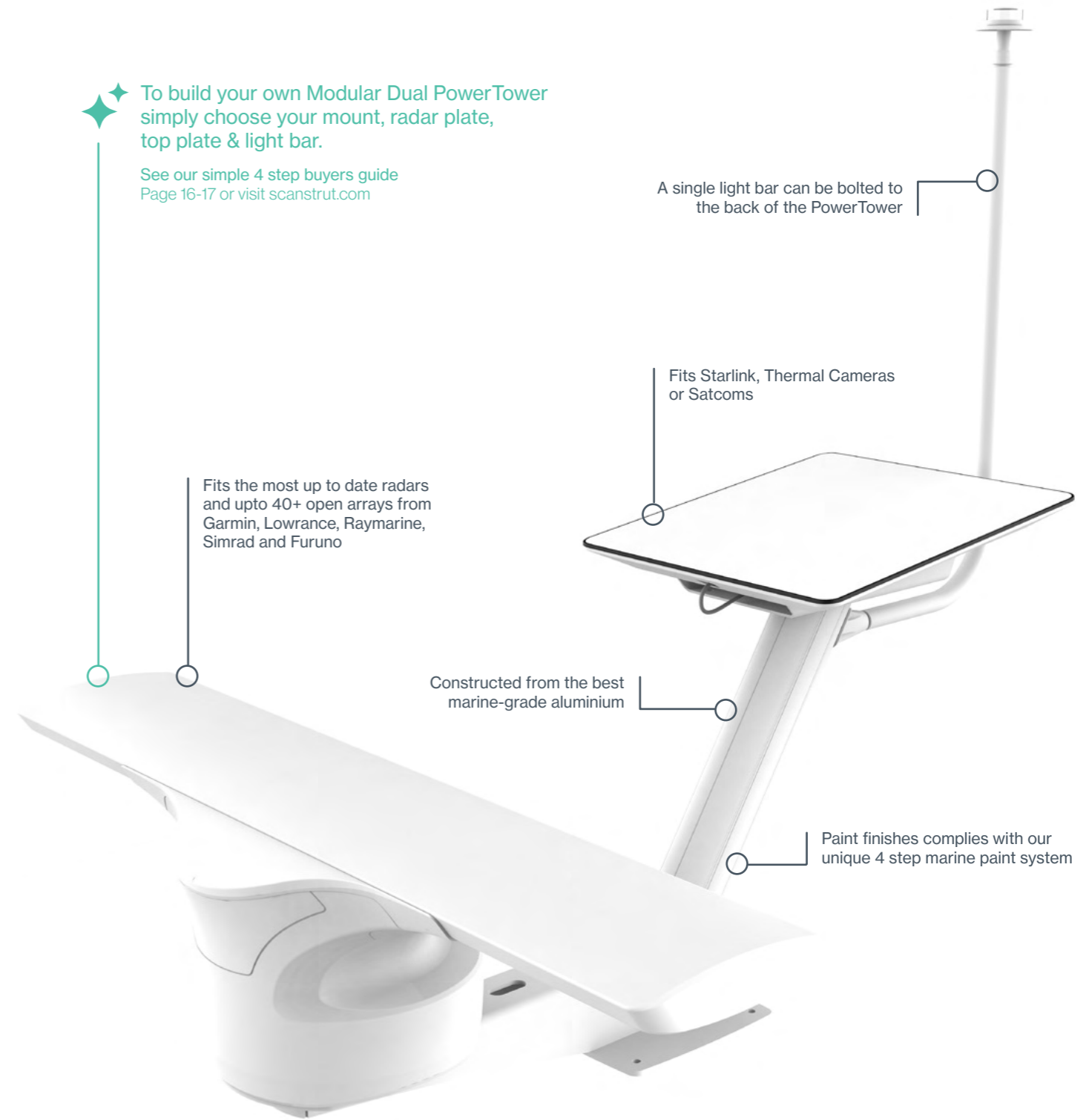

**Step One** Select Mount

1



**DPT-R**  
**Satcom or Radar Mount**  
 Standard installation  
 Small mounting footprint, saves space on your roof or flybridge



**DPT-R-COMP**  
**Satcom or Radar Mount**  
 Compact installation  
 Low-profile  
 Small mounting footprint, saves space on your roof or flybridge



**DPT-OA**  
**Mount Open Array Radar with Satcom or Vessel Camera**  
 Small mounting footprint, saves space on your roof or flybridge  
 Pre-drilled mounting holes allow the radar to fasten straight to the PowerTower with its own mounting bolts

Compatible with

✓ All major radar and satcom manufacturers

✓ All major radar and satcom manufacturers

- ✓ Garmin
- ✓ Raymarine
- ✓ Simrad
- ✓ Furuno

**Step Two** Select Radar Plate

2

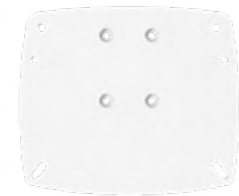

**DPT-R-PLATE-01**  
**Radome Plate 1**

Compatible with

- ✓ Garmin
- ✓ Raymarine
- ✓ Simrad
- ✓ Lowrance
- ✓ B&G

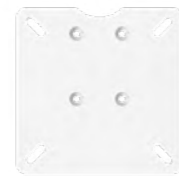

**DPT-R-PLATE-02**  
**Radome Plate**

Compatible with

- ✓ Furuno



**DPT-OA-PLATE-01**  
**Open Array Plate 1**

Compatible with

- ✓ All open array radar models

**Step Three** Select Top Plate

3

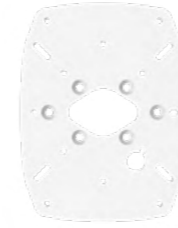

**DPT-S-PLATE-01**  
**Satcom Plate 1**  
 Designed for Satcoms up to 30cm (12")

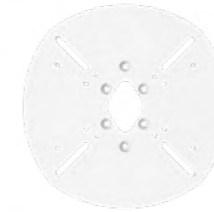

**DPT-S-PLATE-02**  
**Satcom Plate 2**  
 Designed for Satcoms up to 45cm (17")

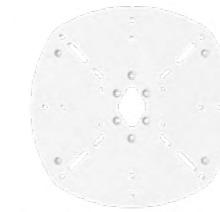

**DPT-S-PLATE-03**  
**Satcom Plate 3**  
 Designed for Satcoms up to 60cm (24")



**DPT-C-PLATE-01**  
**Camera plate 1**  
 FLIR M series, Sionyx Nightwave Cameras & searchlights

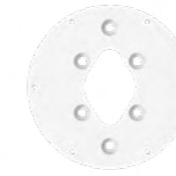

**DPT-C-PLATE-02**  
**Camera plate 2**  
 FLIR M100/200 Thermal Imaging Cameras

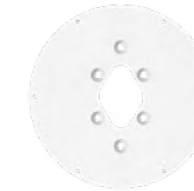

**DPT-C-PLATE-03**  
**Camera plate 3**  
 FLIR M300 Thermal Imaging Cameras



**SC-SL-01**  
**Starlink**  
 Designed to fit Starlink High-Performance

**Step Four** Select Lightbar

4



**DPT-LB-01**  
**Central Lightbar**  
 For use with up to 45cm domes



**DPT-LB-02**  
**Central Lightbar**  
 For use with up to 60cm domes & Starlink

RADAR MOUNTS

RADAR MOUNTS



Pre-drilled mounting holes allow the radar to fasten straight to the Tapered Mast



No need to cut plugs to install (NMEA plug compatible wings)



Undrilled top plate to fit any light



Marine-grade aluminium



Small base footprint - same as Scanstrut Dual PowerTower



Unique 4 step marine paint system



# Tapered Mast

This flagship radar mount is a single combination mount designed for radar, lights, GPS/VHF antennas, cameras, searchlights and satcom or Starlink. Each item is perfectly positioned for maximum performance.

Available in



★ Available on request



PTM-R1-1

**Tapered Mast • 2 Devices**

Colour White

Material Marine-grade aluminium

Also mount lights, cameras, GPS/ VHF antenna



PTM-R1-2

**Tapered Mast • 2 Devices**

Colour White

Material Marine-grade aluminium

Also mount lights, cameras, GPS/ VHF antenna



PTM-R1-S40

**Tapered Mast • 3 Devices**

Colour White

Material Marine-grade aluminium

Designed to fit:

- 1 x Radar
- 1 x 40cm Satcom
- 1 x Vessel Camera
- 4 x Antenna



PTM-R2-S40

**Tapered Mast • 3 Devices**

Colour White

Material Marine-grade aluminium

Designed to fit:

- 1 x Radar
- 1 x 40cm Satcom
- 1 x Vessel Camera
- 4 x Antenna



PTM-R1-SL

**Tapered Mast for Radar and Starlink**

Colour White

Material Marine-grade aluminium

Designed to fit:

- 1 x Radar
- 1 x Starlink Flat High-Performance
- 1 x Vessel Camera
- 4 x Antenna



PTM-R2-SL

**Tapered Mast for Radar and Starlink**

Colour White

Material Marine-grade aluminium

Designed to fit:

- 1 x Radar
- 1 x Starlink Flat High-Performance
- 1 x Vessel Camera
- 4 x Antenna

Compatible with

- ✓ Garmin
- ✓ Raymarine
- ✓ Simrad
- ✓ Lowrance

- ✓ Furuno

- ✓ Garmin
- ✓ Raymarine
- ✓ Simrad
- ✓ Lowrance
- ✓ KVH
- ✓ Flir
- ✓ Intellian

- ✓ Furuno
- ✓ KVH
- ✓ Flir
- ✓ Intellian

- ✓ Garmin
- ✓ Raymarine
- ✓ Simrad
- ✓ Lowrance

- ✓ Furuno



# Mast Mounts

The original and first choice for boat owners around the world, Scanstrut Mast Mounts are a cost-effective and space-saving solution for installing your Radome or Satcom antenna. Scanstrut range of products each specifically designed to get the maximum efficiency out of any of the leading manufactures radars and are made from marine-grade aluminium and coated with our unique 4-step marine paint system. Making sure that your mast mount stays looking its best year in, year out, whatever the oceans throw at it.

Available in



SC20  
 Colour White  
 Material Marine-grade aluminium



SC20-BLK  
 Colour Black  
 Material Marine-grade aluminium



SC18  
 Colour White  
 Material Marine-grade aluminium



SC21  
 Colour White  
 Material Marine-grade aluminium



SC12  
 Colour White  
 Material Marine-grade aluminium

## Compatible with

- ✓ 18" Garmin
- ✓ Raymarine
- ✓ 18" Simrad
- ✓ 18" Lowrance

- ✓ Garmin
- ✓ Raymarine
- ✓ Simrad
- ✓ Lowrance

- ✓ Legacy Furuno
- ✓ Legacy JRC

- ✓ 24" Furuno
- ✓ 24" Simrad
- ✓ 24" Lowrance

- ✓ Furuno

RADAR MOUNTS



M92698  
 Colour White  
 Material Marine-grade aluminium



M92722  
 Colour: White  
 Material: Marine-grade aluminium

Compatible with

- ✓ Raymarine RD424
- ✓ Raymarine RD424HD

- ✓ 24" Raymarine
- ✓ 24" Garmin
- ✓ 24" Simrad
- ✓ 24" Lowrance

**Radar Guards**

Our polished stainless guards protect radome from damage and reduce wear on the sails.

Range Features:

- Mounted using radome bolts
- Easy to fit – between mast mount and radar antenna
- No extra fastenings required
- Manufactured from marine grade 316 stainless steel



Mast Mount Compatibility

Radar Guard SKU	SC12	SC18	SC21	M92698	M9722
SC24	✓	✓	-	-	-
SC25	✓	-	-	-	-
SC27	-	-	✓	✓	✓
SC28	-	-	✓	✓	✓
SC29	-	-	✓	✓	✓



2

Supplied with two support struts which provide maximum fore/aft and sideways support



For racing or winter storage, simply remove the pole by unscrewing the base and remove pole, leaving just the low profile base on deck



2 x heights available



# Pole Mounts

SC100 pole mount range installs your radar onto the deck or transom of your boat. Supplied as a complete kit, you will have everything you need for your installation. The anodized aluminium base gives choice when deciding where you wish to install the pole mount, it has a rotation of 360 degree that enables the pole to be installed on both sloping transoms and level decks. The Pole features two cable channels with a cover strip to hold cables in place and out of view. Perfect choice for the serious bluewater cruiser as you can mount various accessories including the SC120 Lifting Crane and Deck Lights.

Available in



SC101  
Height 1.9m (6.4')



SC102  
Height 2.5m (8.3')



SC103  
Height: 1.9m (6.4')



SC104  
Height 2.5m (8.3')



SC120  
**Lifting Crane complete with all fixings & tackle**  
Ideal for lifting/lowering heavy outboards, luggage, supplies onboard.  
Crane swings through 270°  
Max Lifting Weight 30kg / 66lbs



White | Black  
SC-SL-01 | SC-SL-01-BLK  
Pre-drilled mounting holes allow the hardware to fasten directly to the wedge  
Built-in Scanstrut Cable Seal ensures a watertight installation  
No need to cut the Starlink connectors for installation  
SC103 or SC104 required to complete installation

Compatible with



- ✓ SC101
- ✓ SC102
- ✓ SC103
- ✓ SC104

- ✓ Starlink Flat High-Performance

RADAR MOUNTS



# Self Levelling Radar Mounts

Self-levelling mount range ensures your radar stays level with the horizon at all times for optimum performance.

Available in



## Backstay Leveller

- Designed to fit the most up to date radars from Garmin, Raymarine, B&G and Furuno.
- Available positioned forward or aft of backstay.
- Features a fine-tuned damping system which reacts to major changes in heel angle of the boat.
- 2.6m (8'6") aluminium mounting pole, supplied in 2 lengths.
- Base can be deck, transom or chainplate mounted.
- Can be installed on both adjustable and split backstays
- Clamps around backstay allowing cable tension to be adjusted.
- Additional 0.6m (23.6") and 1.3m (51.1") lengths available to mount your radome higher.
- No power required
- Oil filled damping chamber



## Mast Leveller

- Designed to fit the most up to date radars from Garmin, Lowrance, Raymarine, B&G and Furuno
- Anodised aluminium damping chamber
- 316 stainless steel radar cradle
- No power is required
- GPS/VHF accessories available
- Oil filled damping chamber



## Pole Leveller

- Complete kit including base, pole, levelling cradle, deck strut & rail standoff.
- Leveller Mounted on 2.5m SC100 Pole Mount
- 316 stainless steel radar cradle
- Maintenance-free
- No power is required
- GPS/VHF accessories available
- Oil filled damping chamber



**LMB-F1**

Mounts forward of the backstay  
 2.6m (8'6") aluminium mounting pole  
 No power required  
 GPS, VHF accessories available  
 316 cradle



**LMB-F2**

Mounts forward of the backstay  
 2.6m (8'6") aluminium mounting pole  
 No power required  
 GPS, VHF accessories available



**LMB-A1**

Mounts aft of backstay  
 2.6m (8'6") aluminium mounting pole  
 No power required  
 GPS, VHF accessories available



**LMB-A2**

Mounts aft of backstay  
 2.6m (8'6") aluminium mounting pole  
 No power required  
 GPS, VHF accessories available

Compatible with

- ✓ Garmin
- ✓ Raymarine
- ✓ B&G

- ✓ Furuno

- ✓ Garmin
- ✓ Raymarine
- ✓ B&G

- ✓ Furuno



**LMM-1**

316 stainless steel radar cradle  
 Maintenance-free  
 No power required  
 GPS/VHF accessories available



**LMM-2**

316 stainless steel radar cradle  
 Maintenance-free  
 No power required  
 GPS/VHF accessories available

Compatible with

- ✓ Garmin
- ✓ Raymarine
- ✓ B&G

- ✓ Furuno



**LMP-1**

Leveller Mounted on 2.5m SC100 Pole Mount  
 316 stainless steel radar cradle  
 Maintenance-free  
 No power is required  
 GPS/VHF accessories available



**LMP-2**

Leveller Mounted on 2.5m SC100 Pole Mount  
 316 stainless steel radar cradle  
 Maintenance-free  
 No power required  
 GPS/VHF accessories available

Compatible with

- ✓ Garmin
- ✓ Raymarine
- ✓ B&G

- ✓ Furuno

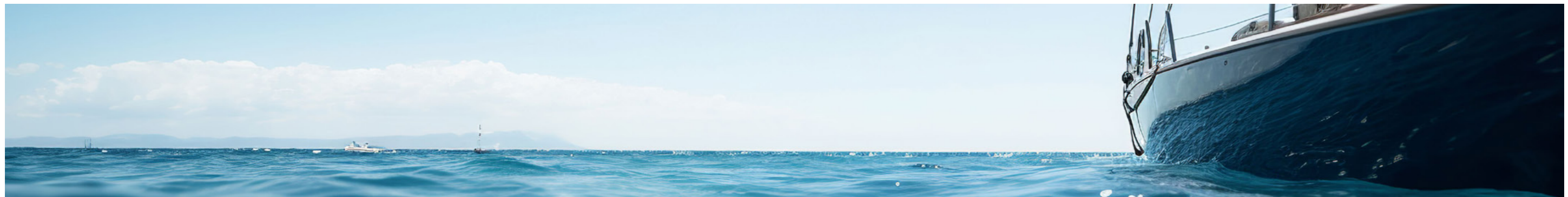



External antenna fixings for easy installation and maintenance



Watertight installation



Single piece composite GRP moulding or 316 stainless steel



No need to remove connectors



# Satcom Antenna Mounts

Scanstrut Antenna Mounts are manufactured from a single piece composite GRP moulding or 316 stainless steel for high strength, corrosion-free mounting. Your chosen antenna will fix on through external fixings and pre-drilled mounting holes, this makes them easy to install and maintain. All the cable routing for the antenna is through the base of the mount which leaves a clean and simple finish.

Available in



**SC30**

Manufactured from a single piece of composite GRP moulding

Reduce the overall footprint of your antenna by up to 55%

External fixings and pre-drilled mounting holes

Easy to install and maintain



**SC35**

Manufactured from a single piece of composite GRP moulding

Reduce the overall footprint of your antenna by up to 30%

External fixings and pre-drilled mounting holes

Easy to install and maintain



**SC45**

Manufactured from a single piece of composite GRP moulding

Reduce the overall footprint of your antenna by up to 45%

External fixings and pre-drilled mounting holes

Easy to install and maintain



**SC45R**

Manufactured from a single piece of composite GRP moulding

Reduce the overall footprint of your antenna by up to 45%

External fixings and pre-drilled mounting holes

Easy to install and maintain



**SC65**

Manufactured from a single piece of composite GRP moulding

Reduce the overall footprint of your antenna by up to 55%

External fixings and pre-drilled mounting holes

Easy to install and maintain



Scan for compatibility

SATCOM MOUNTS



SC80

**Antenna Mount**

Marine-grade 316 Stainless Steel  
Reduce the overall footprint of your antenna by up to 35%

Cables installed through KDL gland plate  
IP68 waterproof rating



SC91

**Antenna Mount**

Largest Satcom Antenna Mount in the range  
Marine-grade 316 Stainless Steel

Mirror polished for a hi-end finish  
Ultra-Robust Mounting Option



HS-01 Hinge Base Mount

**Antenna Mount**

30cm (12") Satcoms only

The hinge system is designed to safely pivot your Satcom installation through 180°, significantly lowering the height of the installation.

Accessories



SC50

**Adjustable Base Wedge**

Quickly and easily provides a level mounting surface on any slope up to 12°.

Scan for compatibility



Compatible with

- ✓ SC35
- ✓ SC45
- ✓ SC45R
- ✓ SC65





Pre-drilled mounting holes allow the hardware to fasten directly to the wedge



Built-in Scanstrut Cable Seal ensures a watertight installation



Marine-grade aluminium



Marine sealant not required

# Starlink Flat High-Performance Mounts

Are you ready to take your Starlink experience to the next level? Look no further than Scanstrut, the industry leader in innovative and reliable marine mounting solutions. Scanstrut Starlink Mounts are engineered to optimize your Starlink performance, ensuring you get the best possible internet connectivity, no matter where you are out on the water.

Available in\*



\*Not pole or DPT itself



White APT-150-SL-01 | Black APT-150-SL-01-BLK

Pre-drilled mounting holes allow the hardware to fasten directly to the tower

Height 150mm (6")

Range of accessory light bars

Built-in Scanstrut Cable Seal ensures a watertight installation

No need to cut the Starlink connectors for installation



White SC-SL-01 | Black SC-SL-01-BLK

Pre-drilled mounting holes allow the hardware to fasten directly to the wedge

Built-in Scanstrut Cable Seal ensures a watertight installation

No need to cut the Starlink connectors for installation

Mounting options include Pole or Modular Dual Power Tower



PTM-R2-SL

Material Marine-grade aluminium

Access panels on the underside of the wings for ease of wiring

Watertight installation

No marine sealant is required



White PTM-R1-SL | Black PTM-R1-SL-BLK

Material Marine-grade aluminium

Access panels on the underside of the wings for ease of wiring

Watertight installation

No marine sealant is required

Compatible with

✓ Starlink Flat High-Performance

✓ Starlink Flat High-Performance

✓ Furuno

✓ Garmin  
 ✓ Raymarine  
 ✓ Simrad  
 ✓ Lowrance

 Pre-drilled mounting holes to allow radar to fasten straight to the PowerTower

 Marine sealant not required

 2 x heights available

 Marine-grade aluminium



# Camera PowerTower®

Scanstrut space-saving PowerTower designs ensure the choice is yours when it comes to deciding where to install your cameras. Our Aluminium Camera PowerTower has been designed and engineered to install your Vessel Camera on the roof, T-top, flybridge or radar arch of your powerboat, providing the clearest view of the horizon allowing you to get the best performance from your marine camera in all conditions.

Available in



**CAM-PT-150-01**  
Colour White  
Material Marine-grade Aluminium  
Height 150mm (6")



**CAM-PT-150-02**  
Colour White  
Material Marine-grade Aluminium  
Height 150mm (6")



**CAM-PT-300-02**  
Colour White  
Material Marine-grade Aluminium  
Height 300mm (12")



**CAM-PT-150-03**  
**Camera PowerTower®**  
Colour White  
Material Marine-grade Aluminium  
Height 150mm (6")



**CAM-PT-300-03**  
**Camera PowerTower®**  
Colour White  
Material Marine-grade Aluminium  
Height 300mm (12")



## Compatible with

- ✓ FLIR M Series
- ✓ Sionyx Nightwave Marine Night Vision

- ✓ FLIR M100 Series
- ✓ FLIR M200 Series

- ✓ FLIR M100 Series
- ✓ FLIR M200 Series

- ✓ FLIR M300 Range









- ✓ FLIR M300 Range



# Scanpod

Concise and well designed, our Scanpod Range offers maximum choice and versatility for installing all leading brands of instruments and screens. The range offers contemporary styling and a unique seal and fixing system to provide full instrument protection. Ensuring you get the very highest quality installation on the market. Our Scanpods achieve the perfect viewing angle for your electronics every time.

- Helm Pod** The perfect choice for all cockpit configurations. With options to fit radar displays, chart plotters and standard navigation instruments.
  - Deck Pod** Simply release the lever, swivel and tilt to suit your perfect viewing angle.
  - Rail Pod** Perfect for installations where there is limited space available.
  - Arm Pod** Install your MFD onto any standard or curved rail, right where you need it the most.
-

-  Universal helm fitting
-  Fits pedestal rails from 25mm to 33.7mm (0.98" – 1.33") diameter
-  Saddles allow internal tube cable routing
-  Watertight seal and cable entry
-  Saddle system supports the stainless tubing enabling a secure and rigid fit onto any pedestal
-  Quick and safe install & repeat servicing
-  Pod seal is manufactured from a high tear strength silicone with a very high resistance to heat and UV
-  As standard, you will receive your Scanpod uncut. For a small charge, factory cutting service is available.



# Helm Pod

Scanstrut Helm Pod is a perfect choice for all cockpit configurations. With options to fit radar displays, chart plotters and standard navigation instruments, the choice is yours! Scan the QR code against each product to check compatibility.

Available in



## Instruments



**SPH-3I-W**  
Fits 3x Standard Nav Instruments & Autopilots



**SPH-4I-W**  
Fits 4x Standard Nav Instruments & Autopilots



**SPH-4XI-W**  
Fits 4x Standard Nav Instruments & Autopilots  
Features an angled face to improve user viewing



## MFD



**SPH-8-W**  
Fits up to 9" displays  
Fits 8" centres



**SPH-9-W**  
Fits up to 9" displays  
Fits 12" centres  
Designed for the most up-to-date screens



**SPH-12-W**  
Fits up to 12" displays  
Fits 12" centres



**SPH-13-W**  
Fits up to 12" displays  
Fits 12" centres  
Designed for the most up-to-date screens



**SPH-15-W**  
Fits up to 16" displays  
Designed for large screens or multi-screen installations



## Instruments & MFD



**SPH-SYSTEM-W**  
Fits up to 12" displays and instruments



## Accessories



**FM-1**  
**Flex Mount - Small**  
Easy to use quick release lever - tilt display forward / back for improved instrument viewing  
Cables exit the back of the Pod and into the pedestal/rail using a watertight grommet  
Fits 1" and 1 1/4" rail sizes and requires a minimum of 60mm (2.4") of straight rail to mount  
**Compatible with** SPH-9-W, SPH-3i-W, SPH-4i-W, SPH-4xi-W



**FM-2**  
**Flex Mount - Large**  
**Compatible with** SPH-12-W, SPH-13-W



-  As standard, you will find your Scanpod uncut.
-  Inner bracing plate secures the Deck Pod base to the pod and gives increased rigidity
-  Install on virtually any flat surface
-  360° viewing angle
-  High UV & heat resistance
-  One-handed quick-release action
-  Hidden internal cable routing through base

# Deck Pod

Concise and well designed, Scanstrut Deck Pod range offers maximum choice and versatility for installing all leading brands of instruments and screens. The range offers contemporary styling and a unique seal system to provide full instrument protection. Ensuring you get the very highest quality installation on the market, choose the Scanstrut Deck Pod and achieve the perfect viewing angle for your electronics every time. Scan the QR code against each product to check compatibility.

Available in



**SPD-4Xi-W**  
Fits 3x Standard Nav Instruments & Autopilots



**SPD-7S-W**  
Fits up to 8" displays



**SPD-7-W**  
Fits up to 8" displays



**SPD-8-W**  
Fits up to 9" displays



**SPD-9-W**  
Fits up to 9" displays  
Designed for modern screens with button controls



**SPD-12-W**  
Fits up to 12" displays



**SPD-13-W**  
Fits up to 12" displays  
Designed for modern screens with button controls





**SPD-15-W**  
Fits up to 16" displays





SCANPODS

 Viewing angle can be set upon installation

 Fit your display onto standard and curved rails

 Range fits rails from 25mm to 33.7mm (1" - 1 1/4")

 Watertight seal and cable entry

 Cables are routed internally through the clamp and onto the rail

 Quick and safe install & repeat servicing

 Pod seal is manufactured from a high tear strength silicone with a very high resistance to heat and UV

 Fixings fit from back to front cutting their threads into injection moulded ABS inserts designed into the Pod front



# Rail Pod

Scanstrut Rail Pod allows you to install your MFD (Multi Functional Display) onto any standard or curved rail and is perfect for installations where there is limited space available.

Available in



### SPR-1I-RM

Fits 1 standard instrument  
Fits rails from 25mm to 33.7mm (0.98" to 1.33")  
Cables are routed internally into the rail



### SPR-1U-RM

Fits small screens, switches, controllers, chain counters and more  
Fits rails from 25mm to 33.7mm (0.98" to 1.33")  
Cables are routed internally into the rail



### SPR-7S-RM

Fits 7" displays or standard Instruments  
Fits rails from 25mm to 33.7mm (0.98" to 1.33")  
Cables are routed internally into the rail



### SPR-7-RM

Fits 7" - 8" displays  
Fits rails from 25mm to 33.7mm (0.98" to 1.33")  
Cables are routed internally into the rail



### SPR-8-RM

Fits 8" and 9" displays  
Fits rails from 25mm to 33.7mm (0.98" to 1.33")  
Cables are routed internally into the rail

Scan for compatibility





-  Fit onto standard curved rails
-  Quick and safe install & repeat servicing
-  Cables routed internally through the clamp and onto the rail
-  Anodised aluminium arm

# Arm Pod

Scanstrut Arm Pod allows you to install your display onto any standard or curved rail. Waterproof internal cable routing allows you to seamlessly run your cables through the bottom of the pod, through the multi-adjustable aluminium clamp and into the rail. This gives you the cleanest and most user-friendly way to mount your MFD (Multi Functional Display) right where you need it the most. Designed for both MFD's and instruments and available for 5" up to 9" displays.

Available in



**SPR-1i-AM**  
 Fits 1 standard instrument  
 Fits rails from 25mm to 33.7mm (0.98" to 1.33")  
 Cables are routed internally into the rail



**SPR-1U-AM**  
 Fits small screens, switches, controllers, chain counters and more  
 Fits rails from 25mm to 33.7mm (0.98" to 1.33")  
 Cables are routed internally into the rail



**SPR-7S-AM**  
 Fits 7" displays or standard Instruments  
 Fits rails from 25mm to 33.7mm (0.98" to 1.33")  
 Cables are routed internally into the rail







**SPR-7-AM**  
 Fits 7" - 8" displays  
 Fits rails from 25mm to 33.7mm (0.98" to 1.33")  
 Cables are routed internally into the rail



**SPR-8-AM**  
 Fits 8" and 9" displays  
 Fits rails from 25mm to 33.7mm (0.98" to 1.33")  
 Cables are routed internally into the rail

Scan for compatibility



-  Quick fit
-  Quick release
-  Marine grade materials
-  Mounts tablets, phones, small fish finders, cameras and more
-  Multiple base options



# ROKK Mini

ROKK Mini is a compact and multi-adjustable mounting system for smart phones, tablets, small fish finders, digital and action cameras and more! Small in size but big on features, ROKK Mini is simply the toughest, most reliable mount for your tech onboard. No compromise.

Available in









RLS-508-401  
ROKK Mini Tablet Mount kit  
with Screw Down Base

RLS-508-404  
ROKK Mini Tablet Mount kit  
with Self-Adhesive Base

RLS-508-405  
ROKK Mini Tablet Mount kit  
with Suction Cup Base

## Accessories

TOP	 RL-508 Tablet Clamp	 RL-509 Phone Clamp	 RL-511 1/4" Camera / Projector Plate
BASE	 RLS-401 Screw Down Base	 RLS-404 Adhesive Base	 RLS-405 Suction Cup Base
BODY	 RLS-AM Adjustable Body		

MOUNT



## USB Charging

---



Waterproof while in use



Fast charge



Marine-grade materials

# USB Charging Waterproof while in use

The waterproof while-in-use series is a game-changer, letting you fast charge without any charging ports being exposed to water. Made with cutting-edge marine-grade materials and designed with longevity, reliability, and ease of use in mind. This series is a great addition to any boat if you want to up your level up your charging experience.



SC-USB-01

IP Rating IPX4

Waterproof with 1, 2 or even 0 cables plugged

The socket will work with any USB Type-A connector

Standard barrel size ø29mm (1/18") hole cutout.



SC-USB-02

**ROKK Charge+**

IP Rating IPX6

Featuring 2 x USB-A charging port

Fast charge

Waterproof with 1, 2 and even no cables plugged in

Ultra-low profile

Standard barrel size ø29mm (1/18") hole cutout.

USB – A output  
2.1A



SC-USB-03

**ROKK Charge Pro**

IP Rating IPX6

Featuring a USB-A and USB-C charging port

Fast charge

Waterproof with 1, 2 and even no cables plugged in

Ultra-low profile

Standard barrel size ø29mm (1/18") hole cutout.

USB – C output  
60W max on 24V system  
36W max on 12V system

USB – A output  
2.1AW max



 IPX4 waterproof

 12 / 24V

 Marine-grade materials

 Contains optional front-fit bezel

 Marine sealant not required

 Low profile

**NEW**  
**Flip Pro**

Scanstrut Flip Pro USB Charge range is a cutting-edge marine-grade charging solution designed to provide reliable and fast outdoor USB charging. The range of chargers combines durable construction, advanced USB and 12V technology, and a user-friendly design to ensure trouble-free charging experience while on the water.

All chargers are supplied with a front-fit bezel



**NEW**  
**SC-12V-F1**  
**Flip Pro 12V Power Socket**  
IP Rating IPX4 when lid is closed  
Input Voltage 12V DC system  
Max Output 10A  
12V system only  
Compact footprint  
Marine-grade materials  
Nickel-Plated copper alloy internal contacts  
Power LED indicator



**NEW**  
**SC-USB-F3**  
**Flip Pro Max - Dual USB-C Charge Socket**  
IP Rating IPX4 when lid is closed  
Voltage 12 & 24V DC system  
Input Current Max 6A  
Output Type C (12V System) 5V / 9V / 12V = 3A Max  
Output Type C (24V System) 5V / 9V / 12V / 15V / 20V = 3A Max  
Protocol QC & PD



**NEW**  
**SC-USB-F4**  
**Flip Pro Plus Fast Charge USB-A & USB-C Socket**  
IP Rating IPX4 when lid is closed  
Voltage 12V & 24V DC system  
Type A/C Dual USB Charger  
Input Current Max 6A  
USB-A (12V System) 5V / 9V / 12V = 3A Max  
USB-C (12V System) 5V / 9V / 12V = 3A Max  
Protocol QC & PD



**NEW**  
**SC-MULTI-F1**  
**Flip Pro Multi - Dual USB-C**  
IP Rating IPX4 when lid is closed  
Voltage 12 & 24V DC system  
Input Current Max 6A  
Output Type C (12V System) 5V / 9V / 12V = 3A Max  
Output Type C (24V System) 5V / 9V / 12V / 15V / 20V = 3A Max  
Protocol QC & PD

**12V Power Socket**  
Voltage 12V system DC system only  
Max Output 10A  
12V system only



**NEW**  
**SC-Multi-F2**  
**Flip Pro Duo - USB-A/C**  
IP Rating IPX4 when lid is closed  
Voltage 12 & 24V DC system  
Max Output 10A  
12V system only  
Type A/C Dual USB Charger  
Protocol QC & PD

**12V Power Socket**  
Voltage 12V DC system only  
Max Output 10A  
12V system only



**SC-USB-F1**  
**Flip Pro**  
IP Rating IPX4 when the lid is closed  
Voltage 12V & 24V DC system  
USB-A (12V System) 5V / 9V / 12V = 3A Max  
USB-C (12V System) 5V / 9V / 12V = 3A Max

**SC-USB-F2**  
**Flip Pro w/ front fit bezel**



USB CHARGING



-  12V & 24V
-  Available as Dual USB-C ports or USB-A and USB-C
-  Ultra-low profile
-  Tiny foot print
-  Available in 316 Brushed Stainless Steel or Matte black
-  Conformal coated electronics, protected against moisture
-  Supplied with 150mm (6") flying lead for easy installation into tight spaces
-  Modernise your boats interiors

**NEW**

# TILE Series

## Tiny Interior Lifestyle Electronics

The Scanstrut TILE Series offers sleek, high-performance charging solutions designed specifically for marine interiors. With elegant bezel options in matte black or premium 316 brushed stainless steel, these chargers blend seamlessly into luxury marine environments. Featuring a compact 40mm square footprint and requiring just a 29mm hole saw for easy installation, the TILE Series combines functionality and style, making it the ideal choice for modernizing your vessel's interior. Enhance your boat's space with this practical, sophisticated solution for everyday device charging.

Available in



Tile USB is FAST! It will charge at 36W on a 12V system or up to 60W on a 24V system. This makes it perfect for charging modern laptops and large tablets, phones and any other USB-C powered devices onboard.



Black Bezel | Brushed Stainless Steel Bezel  
SC-TILE-10 | SC-TILE-11

### TILE - USB-A / USB-C Interiors Charging Socket 12/24V

Voltage 12V & 24V

Type A/C Dual USB Charger

Input Current Max 6A

Protocol QC & PD

Conformal coated electronics, protected against moisture

Ultra-low profile & tiny footprint 40x40mm (1.57x1.57")

USB-A (12V System)  
5V / 9V / 12V = 3A Max

USB-C (24V System)  
5V / 9V / 12V / 15V / 20V = 3A Max

Universal fit for any USB-C connectors

60W fast charge on 24V system USB-C only



Black Bezel | Brushed Stainless Steel Bezel  
SC-TILE-20 | SC-TILE-21

### TILE - USB-C / USB-C Interiors Charging Socket 12/24V

Voltage 12 & 24V

Input Current Max 6A

Output 60W max on 24V system / 36W max on 12V system

Protocol QC & PD

Conformal coated electronics, protected against moisture

Ultra-low profile & tiny footprint - 40x40mm (1.57x1.57")

USB-C (12V System)  
5V / 9V / 12V = 3A Max

USB-C (24V System)  
5V / 9V / 12V / 15V / 20V = 3A Max

Universal fit for any USB-C connectors

Fast charge (60W max) up to 2 devices at a time

#### Range Electrical Info

Input Voltage	10-30V DC (12/24V System)
Input Current Max	6A (10A fuse recommended)
Standby Power Draw	0.01W

#### Important information

To maximize charge performance, use the cable supplied with your tablet, phone etc. (C to C, or C-lightning) Phones charge at the same speed on either a 12 or 24V system, but a 24V system must be used to get the full 60W output for increased charge speed with laptops.



# Waterproof Wireless Charging

Designed from the ground up, this is the world's first waterproof wireless charge system created specifically for use onboard, with the unique technology of either Single or Triple coil, housed in an IPX6, fully encapsulated and sealed unit.

---



IPX6



Wireless charge



Marine-grade materials



# Mount & Charge

Securely holds and wirelessly charges your phone even in the toughest outdoor conditions. Compatible with wireless charging-enabled phones of all sizes from major brands, including Samsung and Apple; charging is possible through non-metallic, waterproof cases.

### Range Electrical Info

Input Voltage	10-30V DC (12/24V System)
Input Current Max	2A
Output Power Max	10W (9V 1.1A)*
Standby Power Draw	<0.2W

\* SC-CW-14G  
Output Power Max - 15W (12V 1.25A)

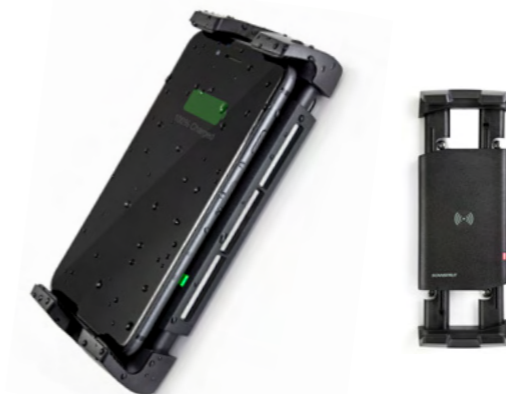

### SC-CW-04F Active 10W

- 10W fast charging
- Qi certified
- High friction grip
- Single-handed docking

- Self-aligning jaws keeps phone in optimal charge position
- Smart LED indicator
- Foreign object detection



### SC-CW-05F Edge 10W

- 10W fast charging
- Qi certified
- High friction grip
- Rotate your phone through 90 degrees

- Switch up your phones viewing angle on the move
- Self-aligning jaws keeps phone in optimal charge position
- Smart LED indicator
- Foreign object detection



### SC-CW-11F Nano 10W

- 10W fast charging
- Qi Certified
- Mount & charge
- Outdoor-ready grip

- Single-handed docking
- Small footprint



### NEW SC-CW-12F Aura 10W

- 10W fast charging
- Mag technology
- Front spring-loaded locking grip
- Install below marine foam, or using the optional top-mount bezel
- Toughened glass



### NEW SC-CW-14G Ultra Qi2

- 15W fast charging
- Qi2-certified
- IPX6 waterproof
- Mag technology
- Toughened glass
- Space saving design

WATERPROOF WIRELESS CHARGE



IPX6 waterproof



Wireless charge



10W output



Qi certified



# 1 Coil Charging

Smaller in dimensions, these chargers offer more installation flexibility.

### Range Electrical Info

Input Voltage	10-30V DC (12/24V System)
Input Current Max	2A
Output Power Max	10W (9V 1.1A)
Standby Power Draw	<0.2W

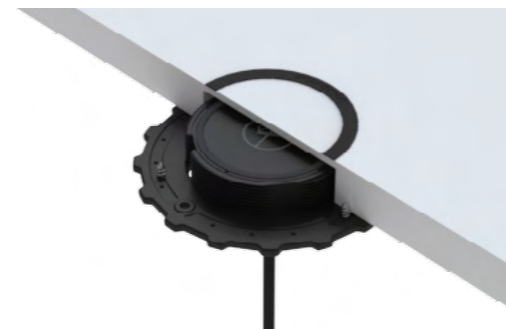

SC-CW-01F

**Hidden**

IP Rating IPX6

10W fast charging

Sub-surface, hidden from view

Pocket or bond install

Ideal for GRP or wood

Allows for customer branding



SC-CW-02F

**Surface**

IP Rating IPX6

10W fast Charging

Low-profile, flush-mounted charge pad

Ultra grippy, non-slip surface

Designed to fit to any smooth surface

Contemporary look with two-tone colour



SC-CW-07F

**Sub**

IP Rating IPX6

10W fast charging

Designed with factory fit in mind

Seamlessly integrates into your interior or exterior design

Bond underneath & wirelessly charge through all non-metallic materials

Allows for custom branding



SC-CW-08F

**Catch**

IP Rating IPX6

10W fast charging

Easy one cut install

Designed to install onto any flat surface, perfect for use on top of boat consoles



 IPX5 - IPX6 waterproof

 Wireless charge

 15W output

 12V / 24V charge

**NEW**  
**3 Coil Charging**

Scanstrut 3 coil charger is made with 3 overlapping coils creating a wide charging area for ease of use as well as ensuring reliable outdoor waterproof charging while easily finding the sweet spot for any phone position.

**Range Electrical Info**

Input Voltage	10-30V DC (12/24V System)
Input Current Max	2A
Output Power Max	15W (12V 1.25A)
Standby Power Draw	<1.2W



**NEW**  
**SC-CW-1GT**  
**Waterproof Wireless Charger - Hidden 3 Coil**  
 15W fast charging  
 Sub-surface, hidden from view  
 Pocket or bond install  
 Ideal for GRP or wood  
 Allows for customer branding





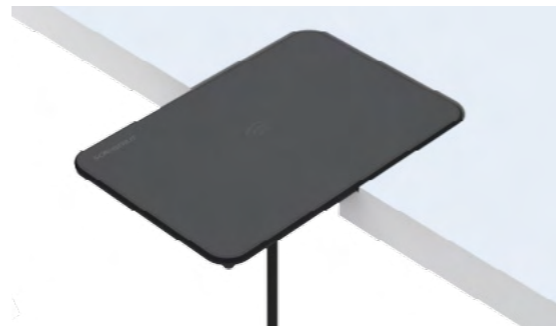

**NEW**  
**SC-CW-2GT**  
**Waterproof Wireless Charger - Surface 3 Coil**  
 15W fast charging  
 Low-profile, flush-mounted charge pad  
 Ultra grippy, non-slip surface  
 Designed to fit to any smooth surface  
 Contemporary look with two-tone colour



**NEW**  
**SC-CW-7GT**  
**Waterproof Wireless Charger - Sub 3 Coil**  
 15W fast charging  
 Designed with factory fit in mind  
 Seamlessly integrates into your interior or exterior design.  
**Recessed Installation** Recess and cover it with a EVA marine foam product for a clean look and added grip for your phone.  
**Surface Installation** Install on top of the surface for a minimal block colour look.  
 Allows for custom branding



-  IPX5 - IPX6 waterproof
-  Wireless charge
-  15W output
-  12V / 24V charge

# NEW 3 Coil Store & Charge

With three overlapping charging coils that maximize performance and ensure reliable charging from various phone placements. Safely houses & wirelessly charges your phone. Perfect for integration into consoles, seating, cabinetry and more! Simply slide your phone into the pocket and instantly start wirelessly charging.

### Range Electrical Info

Input Voltage	10-30V DC (12/24V System)
Input Current Max	2A
Output Power Max	15W (12V 1.25A)
Standby Power Draw	<1.2W



NEW  
SC-CW-6GT  
**Nest 15W 3 Coil**

IP Rating IPX6  
12/24V  
15W Fast Charging

Three overlapping charging coils maximize phone charging area.

Safely houses & wirelessly charges your phone

Perfect for integration into consoles, seating, cabinetry and more!

Perfect for storing other personal items

Rounded corners and tapered front design eliminate all snagging risks

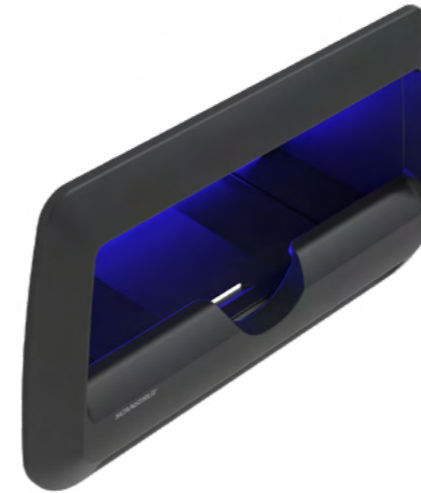

NEW  
SC-CW-10GT  
**Cove LED 15W 3 Coil**

NEW  
SC-CW-9GT  
**Cove 15W 3 Coil**

Safely house & wirelessly charges your phone at the same time. Now you can keep your phone in a safe place onboard, tucked away, charged and ready to go. No alignment is needed, throw your phone into the charger and your phone will always charge!

IP Rating  
SC-CW-10GT IPX5  
SC-CW-9GT IPX6

12/24V  
15W Fast Charging

Three overlapping charging coils maximize phone charging area.

Reverse polarity protection

Uninterrupted charging during outdoor adventures

Rear installation light, for testing power & correct wiring

LED light acts as a quick visual guide to show phone is charging

Simple one-cut installation



NEW  
SC-CW-15G

**Aero 15W 3 Coil – Horizontal Installation**

IP Rating IPX6  
3 charging coils  
15W fast charging  
12/24V

Features an internal sprung lever phone grip

Built-in cooling fan keeps your device charging, even on the hottest days out on the water

NEW  
SC-CW-16G

**Aero 15W 3 Coil – Vertical Installation**

IP Rating IPX6  
3 charging coils  
15W fast charging  
12/24V

Features an internal sprung lever phone grip

Built-in cooling fan keeps your device charging, even on the hottest days out on the water

WATERPROOF WIRELESS CHARGE









# Air

Our in-built air stations are here to maximize your quality time on the water.

---



-  **Waterproof front and back**
-  **Input Voltage**  
12V Battery System (10-14V)
-  **Max Pressure**  
20 PSI / 1.37 Bar
-  **Max Current Draw**  
12A (140W)
-  **Standby Current Draw**  
0.01W Max
-  **Two Stage Pump**  
Stage 1 0 - 1 PSI  
Stage 2 1.1 - 20 PSI
-  **H x W x D**  
198 x 297 x 110mm  
7.80 x 11.69 x 4.33"

**NEW**

# ATMOS 12V Integrated Air Station

This beautifully designed, in-built air station is here to maximize quality time on the water. At the push of a button, ATMOS is ready to inflate your paddle boards, towables and more: simply set the target pressure and let ATMOS do all the hard work. Utilizing Scanstrut outdoor technology DNA, this is waterproof on-board air that's engineered to thrive in the harsh marine environment.



**NEW**  
**SC-AOB-A2**  
**ATMOS 12V Integrated Air Station**

Featuring next-gen air pump technology to provide fast, effortless inflation (and deflation) for your on-water toys. Compact and shallow, ATMOS fits into almost any panel on board such as seating, consoles, or near the swim platform. Now you have ready-to-go air, right where it's needed, for even more family fun on the water.

Easily installed into any panel using 10 self-tapping screws, with a foam gasket included to ensure a secure and waterproof fit. As a standard ATMOS comes with a 2.5m / 8ft hose. Alternatively a 3.6m / 12ft hose is available [SC-AOB-A-HOSEV-12](#)

At Scanstrut, our SCA standard – Safe, Certified, Approved – ensures products thrive in challenging outdoor conditions. Each product undergoes rigorous testing for outdoor reliability and performance by our internal test engineers and accredited test houses.



Scan QR code to view all product tests



## Suggested Placement



## Accessories

SC-AOB-A2-SC1 White ATMOS Sun Cover



SC-AOB-A-HOSEV-12 3.6m / 12ft Hose



### 01 Select the Location

Mount ATMOS on a flat surface ranging from plus-10 to minus-30 degrees from vertical to prevent water accumulation. Avoid curved surfaces. Allow at least 12 ½ inches (horizontal) by 8 ½ inches (vertical) for the faceplate and sun cover, and an additional 3 ½ inches on the left side for the door to swing open. Ensure at least 4 ½ inches of depth behind the mounting surface.

### 02 Create the Cutout

Mask the area to prevent scratching. Tape the supplied template into position. Use a 1 ¾-inch hole saw to cut the four corners, then a thin kerf saw to cut along the lines connecting them. Drill pilot holes for the 10 self-tapping mounting screws. For soft materials, use a 5/64-inch drill bit; for harder materials, use a 3/32-inch bit. Lightly chamfer each hole with a countersink to prevent chipping.

### 03 Install the Unit

Remove the masking tape and slide the unit into the cutout. If concerned about water intrusion, apply silicone sealant around the perimeter and on each screw. Align the faceplate's 10 mounting holes with the pilot holes and drive in the No. 4 self-tapping stainless-steel screws. Do not over tighten. Install the upper and lower snap covers to hide the screws and give a seamless look.

### 05 Test the System

Before going on the water, test ATMOS system by inflating and deflating one of your towable water toys, following the owner's manual instructions. If issues arise, refer to the troubleshooting guide in the manual. When done, close the door hiding the ports, cover the faceplate with the sun cover, and isolate ATMOS.

### 04 Connect to Power

ATMOS has a twin core 2-volt DC power cord: red (positive) and black (negative). Connect the red wire to a positive bus bar linked to an on/off switch from the boat's battery, with a fuse or circuit breaker between. Connect the black wire to a negative bus bar connected to a common ground. Use terminals that are soldered or crimped and covered with heat-shrink tubing to prevent moisture and corrosion. Support the wires and install anti-chafe grommets where the wires pass through bulkheads or decks.



Scan the QR code to find out more or visit [scanstrut.com](https://scanstrut.com)

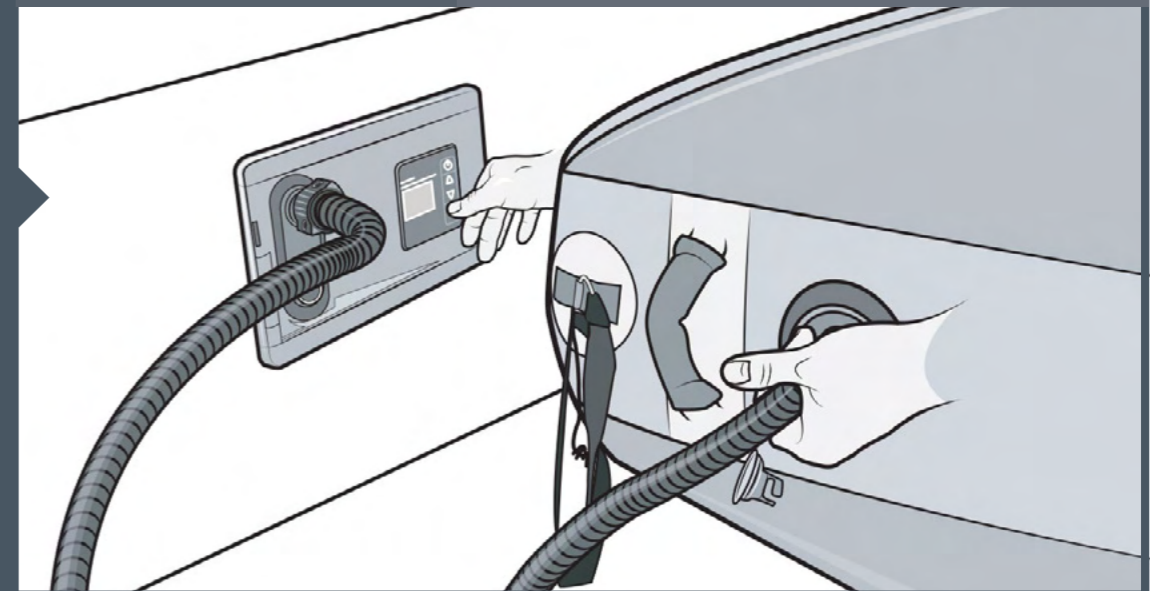



## Cable Seals

Our range of cabling solutions eliminates time-consuming, sub-standard routing of cables and messy sealant to achieve a 100% watertight installation for your marine cables every time.

---



100% watertight



Easy fit cable routing



Marine sealant not required



Perfect for your antenna and navlight cables



Ultra strong & impact resistant



UV stable & hard wearing



Split bung



### Vertical Cable Seals

SKU	Colour	Min. Cable Size (mm / inch)	Max. Cable Size (mm / inch)	Pre-drilled Bungs Supplied (mm / inch)	Fits Connector up to (mm / inch)
DS6-P	Grey	2 / 0.08	6 / 0.24	Self Drill 2 / 0.08 3 / 0.12 4 / 0.16 5 / 0.20 6 / 0.24	-
DS6-P-BLK	Black				
DS16-P	Grey	2 / 0.08	8 / 0.35	Self Drill 3 / 0.12 4 / 0.16 7 / 0.28	Ø 16 / 0.63
DS16-P-BLK	Black				
DS16-S	Stainless				
DS21A-P	Grey	4 / 0.15	9 / 0.35	Self Drill 4 / 0.16 5 / 0.20 7 / 0.28	Ø 21 / 0.82
DS21A-P-BLK	Black				
DS21A-S	Stainless				
DS21B-P	Grey	9 / 0.35	14 / 0.55	Self Drill 9 / 0.35 11 / 0.43 13 / 0.51	Ø 21 / 0.82
DS21B-P-BLK	Black				
DS21B-S	Stainless				
DS30-P	Grey	9 / 0.35	14 / 0.55	Self Drill 9 / 0.35 11 / 0.43 13 / 0.51	Ø 30 / 1.18
DS30-P-BLK	Black				
DS30-S	Stainless				
DS40-P	Grey	12 / 0.47	15 / 0.59	Self Drill 12 / 0.46	Ø 40 / 1.57
DS40-P-BLK	Black				
DS40-S	Stainless				

# Vertical Cable Seals

This premium IP68 waterproof range provides easy fit cable routing that cuts down your installation time. Designed for a range of cable & connector diameters (no minimum diameter) and with options for 2mm to 40mm / 0.07" to 1.57" connectors, making it ideal for almost every installation.

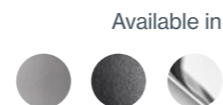





-  100% watertight
-  Easy fit cable routing
-  Marine sealant not required
-  Perfect for solar panels, light bars & other rooftop electronics
-  Ultra strong & impact resistant
-  UV stable & hard wearing

# Horizontal Cable Seals

Horizontal cable seals eliminate time-consuming, sub-standard routing of cables and messy sealant to achieve a 100% watertight installation for your cables every time. Designed to fit a large range of marine cables, available in a single or double seal option.

Available in  



## Horizontal Cable Seals

Designed for single cable installations

SKU	Colour	Min. Cable Size (mm / inch)	Max. Cable Size (mm / inch)	Pre-drilled Bungs Supplied (mm / inch)
<b>DS-H6</b>	Grey	2 / 0.08	6 / 0.24	Self Drill 2 / 0.08 3 / 0.12 4 / 0.16 5 / 0.20 6 / 0.24
<b>DS-H6-BLK</b>	Black			
<b>DS-H10</b>	Grey	6 / 0.24	10 / 0.39	Self Drill 6 / 0.24 7 / 0.28 8 / 0.31 9 / 0.35 10 / 0.39
<b>DS-H10-BLK</b>	Black			



## Double Horizontal Cable Seals

Designed for double cable installations

SKU	Colour	Min. Cable Size (mm / inch)	Max. Cable Size (mm / inch)	Pre-drilled Bungs Supplied (mm / inch)
<b>DS-HD6</b>	Grey	5 / 0.20	6 / 0.24	Self Drill 2x 5 / 0.20 2x 6 / 0.24
<b>DS-HD6-BLK</b>	Black			
<b>DS-HD10</b>	Grey	6 / 0.24	10 / 0.39	Self Drill 2x 6 / 0.24 2x 7 / 0.28 2x 8 / 0.31 2x 9 / 0.35 2x 10 / 0.39
<b>DS-HD10-BLK</b>	Black			

CABLE SEALS



100% watertight



Easy fit cable routing



Marine sealant not required



Perfect for solar panels, light bars & other rooftop electronics



Ultra strong & impact resistant



UV stable & hard wearing

NEW

# Low Profile Cable Seals

This low-profile design reduces the overall seal height by over **70%** when compared to the standard range by concealing the seal technology below the mounting surface. This results in a clean and more refined appearance and enables installation in the tightest of spaces.

Available in



## Low Profile Cable Seals

SKU	Colour	Max. Cable Size (mm / inch)	Pre-drilled Bungs Supplied (mm / inch)	Fits Connector up to (mm / inch)
NEW DS-LP-16-BLK	Black Anodised Aluminium	2 / 0.08	Self Drill 3 / 0.12	Ø 16 / 0.63
NEW DS-LP-16-S	316 Stainless		4 / 0.16 7 / 0.28	
NEW DS-LP-21A-BLK	Black Anodised Aluminium	4 / 0.15	Self Drill 4 / 0.16	Ø 21 / 0.82
NEW DS-LP-21A-S	316 Stainless		5 / 0.20 7 / 0.28	
NEW DS-LP-21B-BLK	Black Anodised Aluminium	9 / 0.35	Self Drill 9 / 0.35	Ø 21 / 0.83
NEW DS-LP-21B-S	316 Stainless		11 / 0.43 13 / 0.51	
NEW DS-LP-30-BLK	Black Anodised Aluminium	9 / 0.35	Self Drill 9 / 0.35	Ø 30 / 1.18
NEW DS-LP-30-S	316 Stainless		11 / 0.43 13 / 0.51	
NEW DS-LP-MULTI-BLK	Black Anodised Aluminium	4 x 15 / 0.59	Self Drill	Ø 15 / 0.59
NEW DS-LP-MULTI-S	316 Stainless			

CABLE SEALS



100% watertight



Easy fit cable routing



Marine sealant not required



Perfect for solar panels, light bars & other rooftop electronics



Ultra strong & impact resistant



UV stable & hard wearing

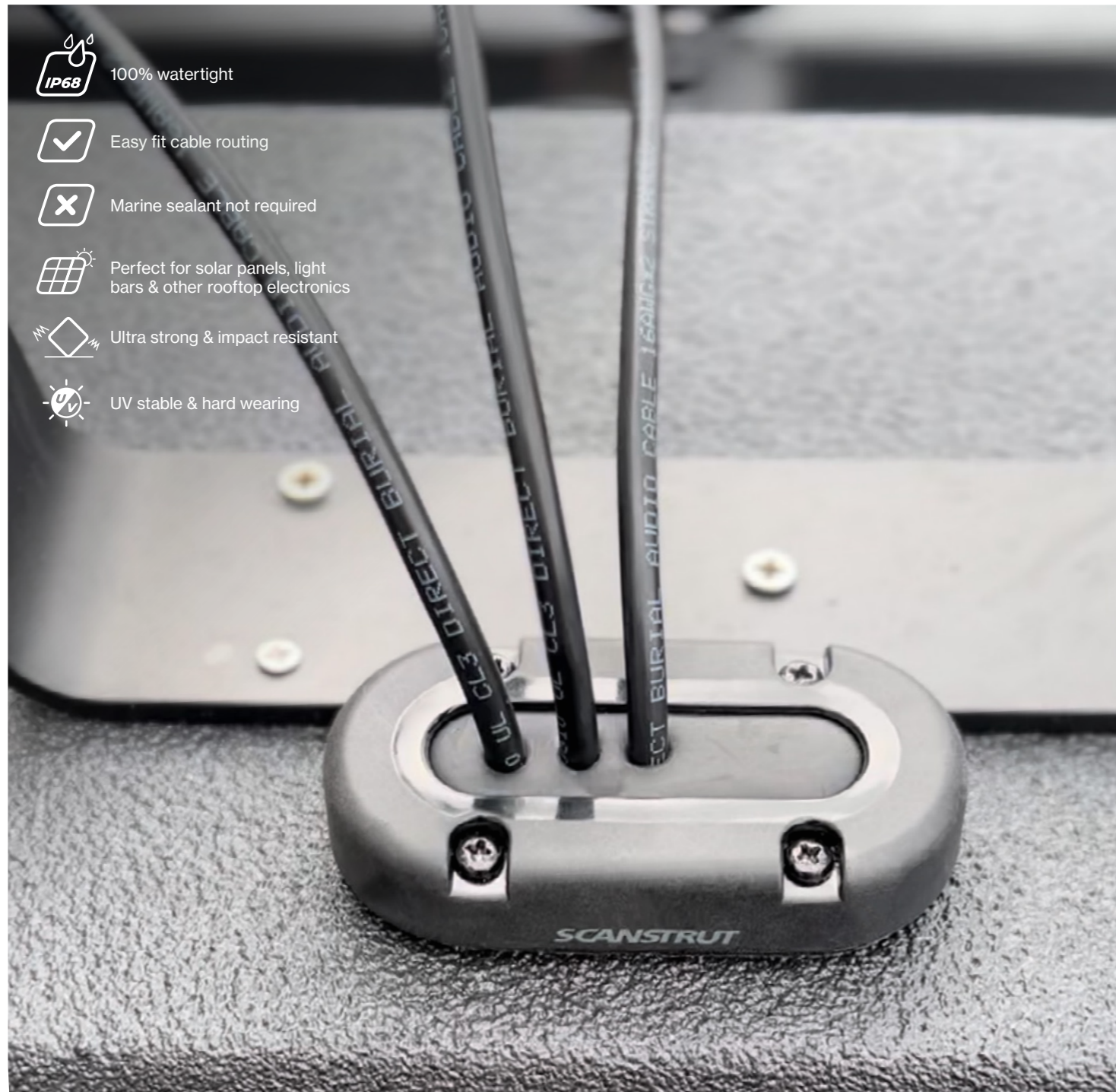

# Multi Cable Seals

A highly versatile range of cabling solutions that eliminate time-consuming, sub-standard routing of cables and messy sealant to achieve a 100% watertight installation for your cables every time. Designed for installing more than 2 cables at a time to maximise your roof space.

Available in



### Multi Cable Seals

Designed for multiple cable installations

SKU	Colour	Max. Cable Size (mm / inch)	Pre-drilled Bungs Supplied (mm / inch)
DS-Multi	Anodised Aluminium	4x 15 / 0.59	Self Drill
DS-Multi-P-BLK	Black Plastic		

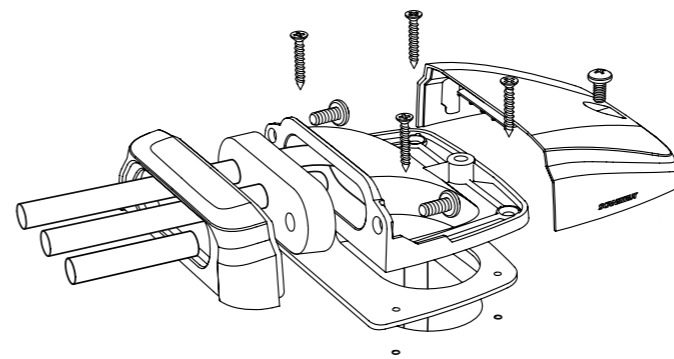

### Horizontal Multi Cable Seals

Designed for multiple cable installations

SKU	Colour	Max. Cable Size (mm / inch)	Pre-drilled Bungs Supplied (mm / inch)
NEW DS-H-Multi-BLK	Black Plastic	4x 15 / 0.59	Self Drill



CABLE SEALS



# Through Bulkhead & Junction Boxes

Available in



**TBH-4**

**Through Bulkhead**

For 4 x 16mm (0.15" x 0.62") cables

For bulkheads 10mm to 35mm (0.39" to 1.37") thick



**TBH-10**

**Through Bulkhead**

For 10 x 7mm (0.39" x 0.27") cables

Fit to any bulkhead 10mm to 35mm (0.39" to 1.37") thick



**SB-8-5**

**Junction Box**

**Material** Marine-grade polypropylene

Features 5 screw-down terminals, offering 5 terminations

Additional SB-2G Cable seals required for IP67 installation



**SB-8-10**

**Junction Box**

**Material** Marine-grade polypropylene

Features 10 screw-down terminals, offering 10 terminations

Additional SB-2G Cable seals required for IP67 installation



**SB-2G**

**Junction Box Connectors**

Upgrade your Scanstrut Junction Box to IP67

Works with both the SB-8-5 and SB-8-10

## Keep in touch

For all the latest from Scanstrut sign up to our mailing list or follow us on Instagram, Facebook or LinkedIn for product features, articles, new releases and more.

Scanstrut by You – Share your adventures and tag your Scanstrut gear in action!

Follow us on  
Instagram



Follow us on  
Facebook



Follow us on  
LinkedIn



## Contact us

### Scanstrut HQ

sales@scanstrut.com

+44 (0)1392 531280

### Scanstrut USA

usasales@scanstrut.com

+1 860 308 1416

## Become a partner

Whether you're a parts reseller, installer, or OEM, we'd love to hear from you if you believe our products can enhance your offerings or business.

- OEM customization available
- In-house design team ready to assist with integration
- ISO 9001 certified for quality assurance
- Custom OEM pricing
- Dedicated support

***SCANSTRUT***<sup>®</sup>

scanstrut.com